

Part Number: PT420-52040

NOTE: Part number of this accessory may not be the same as the part number shown.

Kit Contents

Item #	Quantity Reqd.	Description
1	1	First Aid Kit
2		
3		





Vehicle Service Parts (may be required for reassembly)

Item #	Quantity Reqd.	Description
1		
2		
3		

Hardware Bag Contents

Item #	Quantity Reqd.	Description
1		
2		
3		

Legend

	STOP: Damage to the vehicle may occur. Do not proceed until process has been complied with.
	OPERATOR SAFETY: Use caution to avoid risk of injury.
	CAUTION: A process that must be carefully observed in order to reduce the risk of damage to the accessory/vehicle and to ensure a quality installation.
	TOOLS & EQUIPMENT: Used in Figures calls out the specific tools and equipment recommended for this process.
	REVISION MARK: This mark highlights a change in installation with respect to previous issue.

Additional Items Required For Installation

Item #	Quantity Reqd.	Description
1		
2		
3		

Conflicts

Note: None

Recommended Tools

Personal & Vehicle Protection	Notes
None	
Special Tools	Notes
None	
Installation Tools	Notes
None	
Special Chemicals	Notes
None	

General Applicability

Note: All SCION Vehicles

Recommended Sequence of Application

Item #	Accessory
1	
2	
3	

*Mandatory

Procedure

Care must be taken when installing this accessory to ensure damage does not occur to the vehicle. The installation of this accessory should follow approved guidelines to ensure a quality installation.

These guidelines can be found in the "Accessory Installation Practices" document.

This document covers such items as:-

- Vehicle Protection (use of covers and blankets, cleaning chemicals, etc.).
- Safety (eye protection, rechecking torque procedure, etc.).
- Vehicle Disassembly/Reassembly (panel removal, part storage, etc.).
- Electrical Component Disassembly/Reassembly (battery disconnection, connector removal, etc.).

Please see your Toyota dealer for a copy of this document.

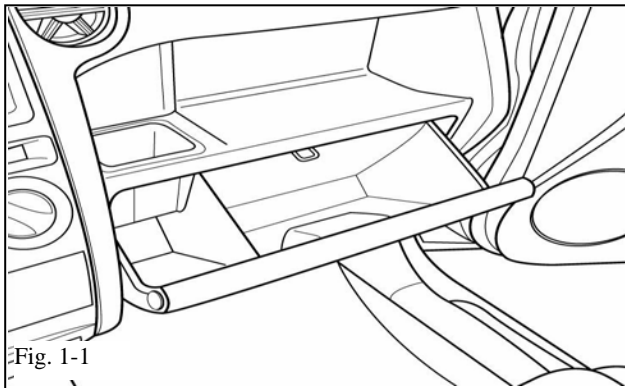

1. Install First Aid Kit.

(A) Remove First Aid Kit from polybag.

(B) Locate and open glove compartment.
(Fig. 1-1)

(C) Place First Aid Kit in glove compartment
with spine facing outward. (Fig. 1-2)



(D) Close glove compartment.

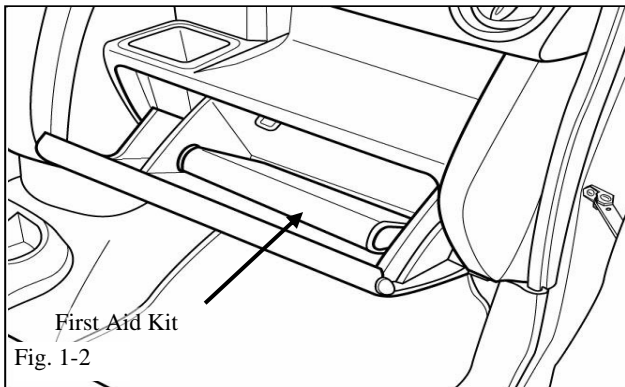

Checklist - these points **MUST** be checked to ensure a quality installation.

Check:

Look For:

Accessory Function Checks

Confirm proper placement of First Aid Kit.

Spine should be facing outward.

Confirm glove compartment is closed.

Glove compartment is securely closed.

Vehicle Function Checks